

## SIMIREL

### Elektronische Zeitrelais Electronic Time Relays Relais temporisés électroniques Relés de tiempo electrónicos Relè elettronici a tempo Relés temporizador eletrônicos

3RP15



IEC/CEI 61812-1

Montageanleitung / Assembly Instructions

Bestell-Nr. / Order No.: 3ZX1012-0RP15-1AA1

	<p><b>⚠️ WARNUNG</b></p> <p><b>Gefährliche elektrische Spannung!</b> Kann zu elektrischem Schlag und Verbrennungen führen. Vor Beginn der Arbeiten Anlage und Gerät spannungsfrei schalten.</p>	<p><b>⚠️ WARNING</b></p> <p><b>HAZARDOUS VOLTAGE.</b> Can cause electrical shock and burns. Disconnect power before proceeding with any work on this equipment.</p>	<p><b>⚠️ ATTENTION</b></p> <p><b>Tension dangereuse !</b> Risque d'électrocution et de brûlure. Isoler cet appareil du réseau avant d'y intervenir pour travaux.</p>
	<p><b>⚠️ PRECAUCIÓN</b></p> <p><b>¡Tensión peligrosa!</b> Puede causar choque eléctrico y quemaduras. Desconectar la alimentación antes de efectuar trabajo alguno en este equipo.</p>	<p><b>⚠️ ATTENZIONE</b></p> <p><b>Tensione elettrica pericolosa!</b> Rischio di shock elettrico e ustioni. Prima di eseguire qualsiasi tipo di lavoro, assicurarsi che l'apparecchio e l'impianto siano scollegati.</p>	<p><b>⚠️ AVISO</b></p> <p><b>Tensão elétrica perigosa!</b> Pode causar um choque elétrico e queimaduras. Antes de iniciar os trabalhos, desligue a tensão da unidade e do aparelho.</p>

Eine sichere Gerätefunktion ist nur mit zertifizierten Komponenten gewährleistet!

Reliable functioning of the equipment is only ensured with certified components.

Le fonctionnement sûr de l'appareil n'est garanti qu'avec des composants certifiés.

El funcionamiento seguro del aparato sólo está garantizado con componentes certificados.

Il funzionamento sicuro dell'apparecchiatura viene garantito soltanto con componenti certificati.

O funcionamento seguro do aparelho apenas pode ser garantido se forem utilizados os componentes certificados.

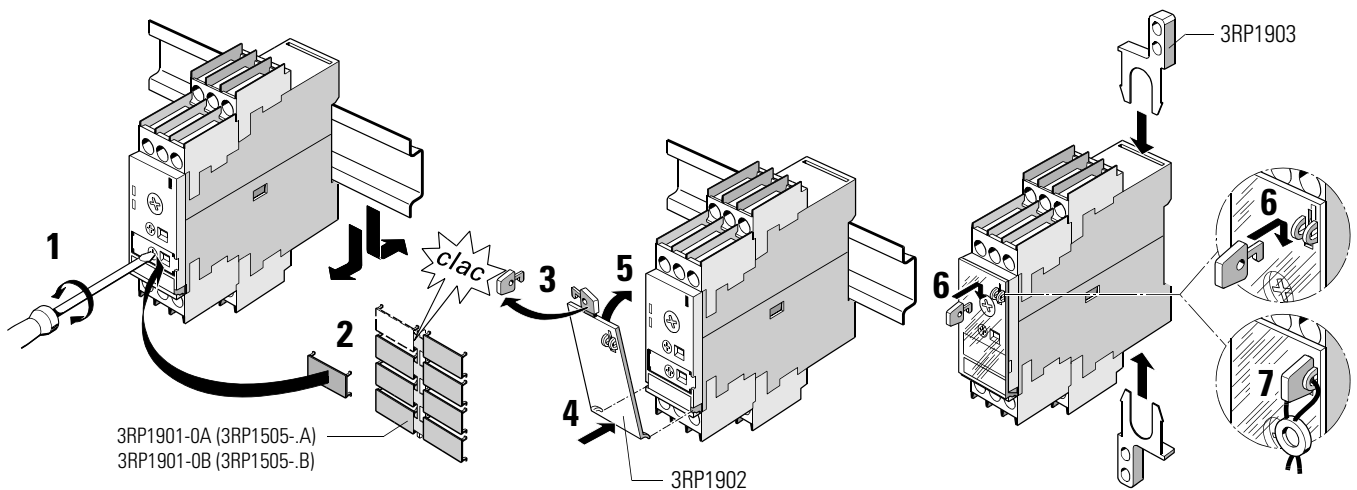

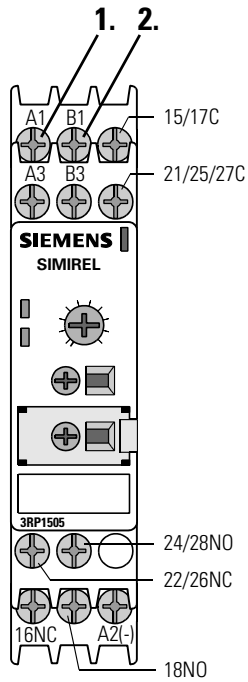

<b>1.</b>	A1/A3: power
<b>2.</b>	B1/B3: power

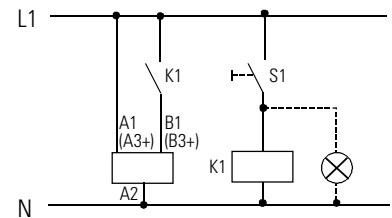
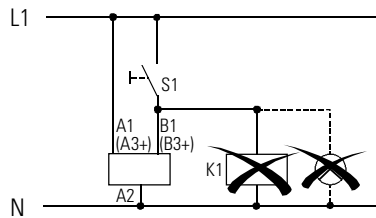
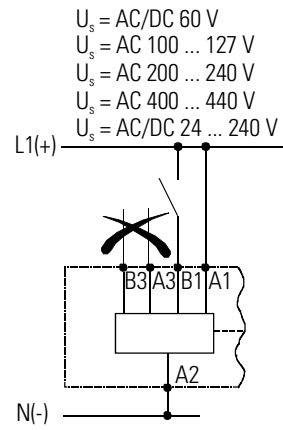
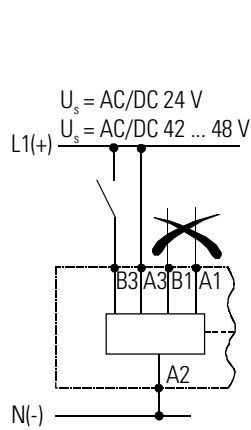

	3RP15..-1	3RP15..-2
 Ø 5 ... 6 mm / PZZ	0,8 ... 1,2 Nm 7 to 10,3 lb-in	—
	1 x 0,5 ... 4 mm <sup>2</sup> 2 x 0,5 ... 2,5 mm <sup>2</sup>	2 x 0,25 ... 1,5 mm <sup>2</sup>
	1 x 0,5 ... 2,5 mm <sup>2</sup> 2 x 0,5 ... 1,5 mm <sup>2</sup>	2 x 0,25 ... 1 mm <sup>2</sup>
<b>AWG</b>	2 x 20 to 14	2 x 24 to 16

**3RP15..-2**

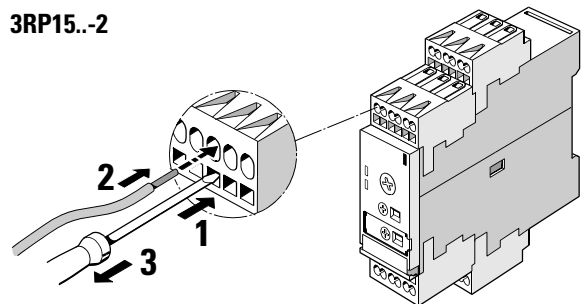

### 3RP1505-1A/-2A/-1R/-2R

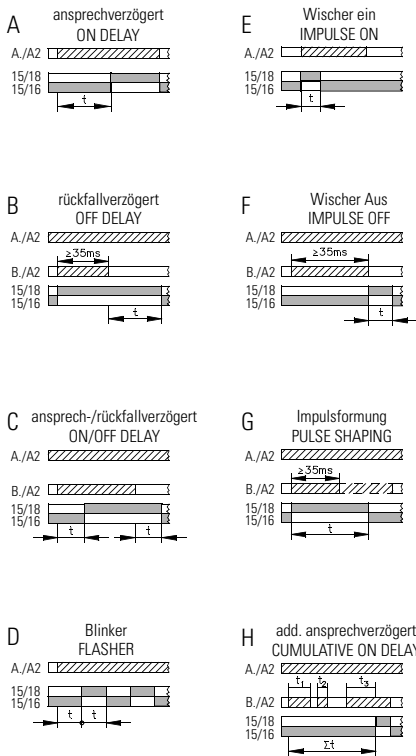

### 3RP1505-1B/-2B

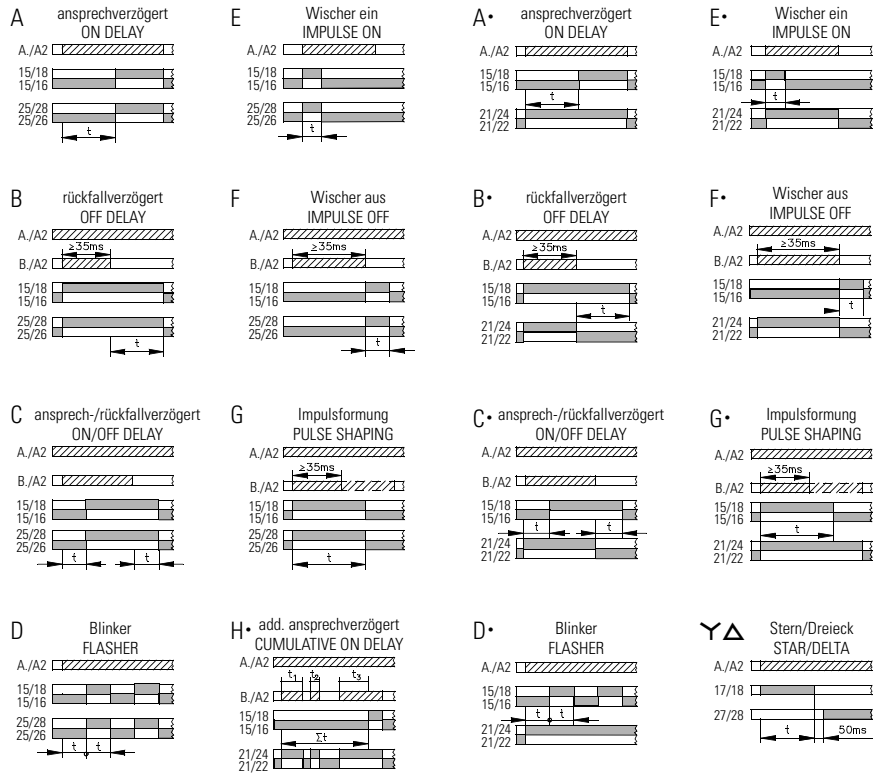

### 3RP151./1525-1A/-2A

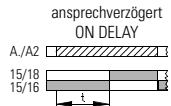

### 3RP1525-1B/-2B

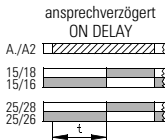

### 3RP1527

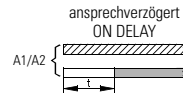

### 3RP153.

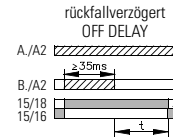

### 3RP1540-1A/-2A

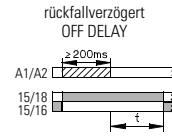

### 3RP1540-1B/-2B

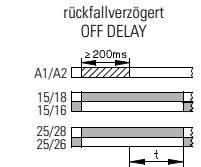

### 3RP1555

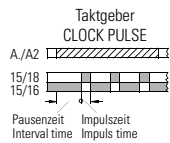

### 3RP157.

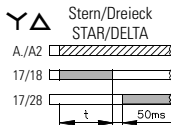

### 3RP1560

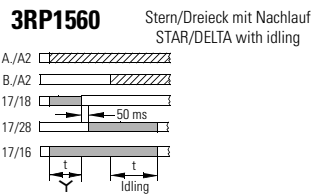

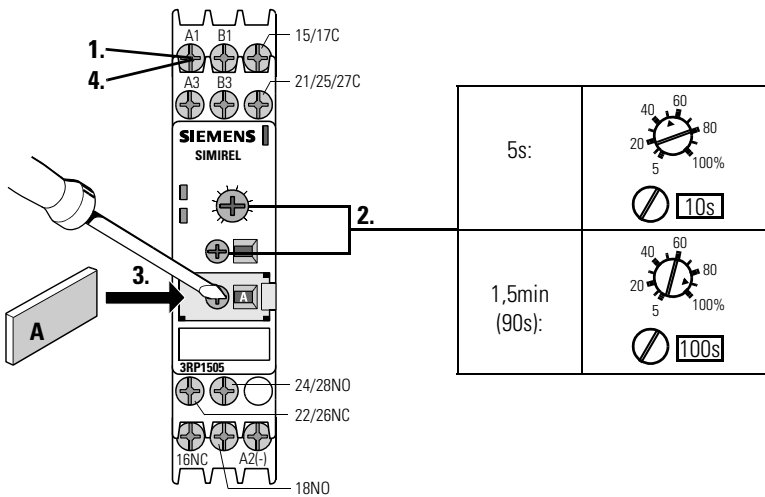

<b>1.</b>	A1/A3: power OFF
<b>2.</b>	
<b>3.</b>	<b>3RP1505</b> 
<b>4.</b>	A1/A3: power ON

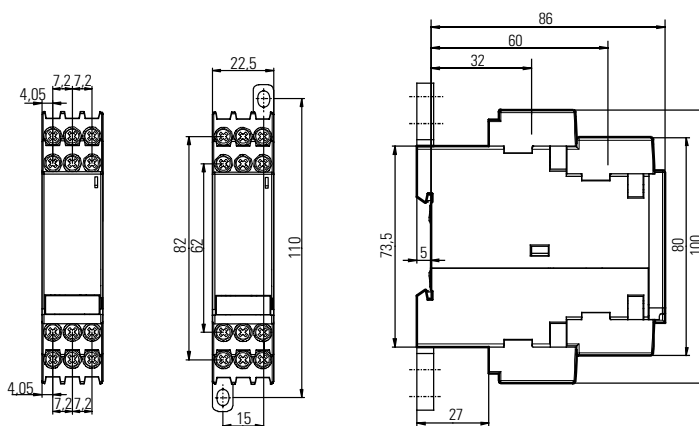
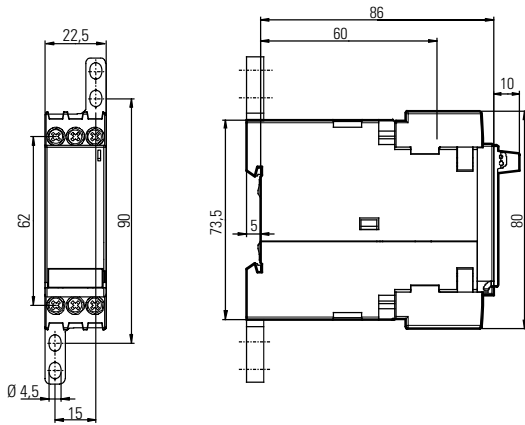

**Technical Assistance:** Telephone: +49 (0) 9131-7-43833 (8<sup>00</sup> - 17<sup>00</sup> CET)  
 E-mail: [nst.technical-assistance@siemens.com](mailto:nst.technical-assistance@siemens.com)  
 Internet: [www.siemens.de/lowvoltage/technical-assistance](http://www.siemens.de/lowvoltage/technical-assistance)

**Technical Support:** Telephone: +49 (0) 180 50 50 222

Fax: +49 (0) 9131-7-42899

Technische Änderungen vorbehalten. Zum späteren Gebrauch aufbewahren!  
 Subject to change without prior notice. Store for use at a later date!  
 © Siemens AG 2002

**Bestell-Nr./Order No.: 3ZX1012-0RP15-1AA1**  
 Printed in the Federal Republic of Germany