

SIEMENS

Molded case switch

Kompaktleistungstrennschalter

Interrupteur en boîtier moulé

Interruptor en caja moldeada

Interruttore automatico scatolato

Interruptor de caixa moldada

Kalıplı kutu şalteri

Переключатель в литом корпусе

Wyłącznik kompaktowy

塑壳开关



3VA51..-1BB2.

3VA51..-1BB3.

UL489

Operating Instructions Betriebsanleitung

Instruções de Serviço İşletme kılavuzu

Notice d'utilisation

Руководство по эксплуатации

Instructivo





Instrukcja obsługi

Istruzioni operative

使用说明

		EN DANGER Hazardous voltage. Will cause death or serious injury. Turn off and lock out all power supplying this device before working on this device. Replace all covers before power supplying this device is turned on.
		NOTICE Installation and maintenance must be carried out by qualified personnel.
DE GEFAHR Gefährliche Spannung. Lebensgefahr oder schwere Verletzungsgefahr. Bevor Arbeiten am Gerät durchgeführt werden, müssen alle Stromquellen ausgeschaltet und mit einer Einschaltversicherung versehen werden. Vor dem Wiedereinschalten der Stromquellen müssen alle Abdeckungen wieder angebracht werden.	FR DANGER Tension électrique dangereuse. Danger de mort ou risque de blessures graves. Avant d'intervenir sur l'appareil, couper toutes les sources de tension et les consigner contre la refermeture. Remettre en place tous les couvercles avant de remettre l'appareil sous tension.	
HINWEIS Installations- und Wartungsarbeiten sind von qualifiziertem Personal durchzuführen.	NOTIFICATION L'installation et la maintenance doivent être effectuées uniquement par des personnes qualifiées.	
ES PELIGRO Tensión peligrosa. Puede causar la muerte o lesiones graves. Antes de trabajar en este dispositivo, desconecte y bloquee todas las fuentes que lo alimentan eléctricamente. Recoloque todas las cubiertas antes de volver a conectar la alimentación eléctrica para este dispositivo.	IT PERICOLO Tensione pericolosa. Può causare la morte o lesioni gravi. Prima di lavorare su questa apparecchiatura, disinserire tutte le fonti di alimentazione elettrica dell'apparecchiatura ed assicurarle contro la reinserzione. Riapplicare tutte le coperture prima di reinserire l'alimentazione di questa apparecchiatura.	
NOTA La instalación y el mantenimiento deben corre a cargo de personal cualificado.	NOTA L'installazione e la manutenzione devono essere eseguite da personale qualificato.	
PT PERIGO Tensão perigosa. Perigo de morte ou ferimentos graves. Desligue e bloqueie todas as fontes de alimentação antes de executar quaisquer trabalhos no aparelho. Volte a colocar todas as coberturas antes de voltar a ligar as fontes de alimentação.	TR TEHLİKE Tehlikeli gerilim. Ölüm tehlikesi veya ağır yaralanma tehlikesi mevcuttur. Cihazda çalışmalar yapılmadan önce, tüm güç kaynakları kapatılmalı ve bir açma emniyetiyle donatılmalıdır. Güç kaynakları tekrar açılmadan önce tüm kapaklar yerlerine takılmalıdır.	
ATENÇÃO A instalação e manutenção têm de ser efetuadas por pessoal qualificado.	NOT Montaj ve bakım işlemleri kalifiye personel tarafından yapılmalıdır.	
РУ ОПАСНО Опасное напряжение. Опасность для жизни или телесных повреждений. До начала работы выключите и заблокируйте все источники питания этого устройства. Перед включением питания снова установите все крышки.	PL ZAGROŻENIE Niebezpieczne napięcie. Niebezpieczeństwo poważnych obrażeń lub utraty życia. Wyłączyć i zablokować wszystkie źródła zasilania urządzenia przed rozpoczęciem pracy na urządzeniu. Założyć wszystkie osłony przed podłączeniem urządzenia do źródła zasilania.	
ПРИМЕЧАНИЕ Установка и техническое обслуживание должны производиться квалифицированным персоналом.	UWAGA Instalacja i konserwacja muszą być wykonywane przez wykwalifikowany personel.	
Technical Support: Internet: http://www.siemens.com/lowvoltage/technical-support		

<p>中  危险</p> <p>危险电压。可能导致生命危险或重伤危险。操作此设备前必须确保切断其电源并采取防接通保护措施。在设备接通电源前，更换所有盖板。</p>	<p>HR  OPASNOST</p> <p>Opasni napon. Opasnost po život ili opasnost od teških ozljeda. Prije rada na uređaju potrebno je isključiti sve izvore struje i osigurati uređaj zaštitom od uključivanja. Prije ponovnog uključivanja izvora struje potrebno je opet postaviti sve poklopce.</p>
<p> 注意</p> <p>安装和维护必须由具备专业资质的人员进行。</p>	<p> NAPOMENA</p> <p>Montažu i održavanje treba obavljati kvalificirano osoblje.</p>
<p>FI  VAARA</p> <p>Vaarallinen jännite. Vakava loukkaantumisvaara tai hengenvaara. Laitteen kaikki virransyöttö tulee katkaista ja sen kytkettyminen päälle tulee estää lukolla ennen kuin laitteeseen kohdistetaan mitään toimenpiteitä. Kaikki kotelot tulee kiinnittää takaisin ennen kuin laitteen virransyöttö kytketään uudelleen päälle.</p>	<p>БГ  ОПАСНОСТ</p> <p>Опасно напряжение. Опасност за живота или опасност от тежки телесни повреди. Преди да извършвате дейности по устройството, изключете и обезопасете всички захранващи източници. Поставете всички капацити на мястото им, преди отново да включите захранването на устройството.</p>
<p> HUOMAUTUS</p> <p>Asennus- ja huoltotyöt on annettava pätevän ammattilaisen suoritettaviksi.</p>	<p> ПРЕДУПРЕЖДЕНИЕ</p> <p>Инсталирането и поддръжката трябва да се извършват от квалифициран персонал.</p>
<p>EE  OHT</p> <p>Ohtlik pinge. Oht elule või raskete vigastuste oht. Enne seadme hooldustöid lülitage kõik toiteallikad välja ja võtke meetmed nende sisselülitamise takistamiseks. Enne toiteallikate uuesti sisselülitamist tuleb kõik katted tagasi paigaldada.</p>	<p>LV  BĪSTAMI</p> <p>Bīstams spriegums. Letālu seku vai smagu traumu risks. Pirms veicat darbu ar šo ierīci pilnībā izslēdziet un nobloķējiet tās strāvas padevi. Pirms ieslēdzat ierīces strāvas padevi uzlieciet atpakaļ visus pārsegus.</p>
<p> MÄRKUS</p> <p>Paigaldus- ja hooldustöid tohib teha ainult kvalifitseeritud personal.</p>	<p> BRĪDINĀJUMS</p> <p>Uzstādīšana un tehniskā apkope jāveic kvalificētiem darbiniekiem.</p>
<p>LT  PAVOJUS</p> <p>Pavojinga įtampa. Pavojus gyvybei arba sunkausi susižalojimo pavojus. Prieš dirbdami ties šiuo prietaisu, išjunkite ir užblokuokite visus šio prietaiso maitinimo šaltinius. Prieš įjungdami šio prietaiso maitinimo šaltinį, vėl uždėkite visus dangčius.</p>	<p>DA  FARE</p> <p>Farlig spænding. Livsfare eller risiko for slemme kvæstelser. Sluk for og lås strømmen, der forsyner denne enhed, før du arbejder med denne enhed. Erstat alle afdækninger, før strømmen, der tilføres denne enhed, tændes.</p>
<p> NUORODA</p> <p>Įrengimą ir techninę priežiūrą turi vykdyti kvalifikuoti darbuotojai.</p>	<p> BEMÆRK</p> <p>Installationen og vedligeholdelsen skal foretages af uddannet personale.</p>
<p>MT  PERIKLU</p> <p>Vultaġġ perikoluż. Riskju ta' mewt jew korriment serju. Qabel taħdem fuq dan l-apparat, itfi kull provvista tal-elettriku tiegħu u sakkar kontra xegħil mill-ġdid aċċidentali. Erġa' installa l-ghotjien kollha qabel tirritorna l-provvista tal-elettriku fl-apparat.</p>	<p>NL  GEVAAR</p> <p>Gevaarlijke spanning. Levensgevaar of gevaar voor ernstig letsel. Voordat u aan dit apparaat werkt, moet u alle actieve energiebronnen voor dit apparaat uitschakelen. Plaats alle afdekkingen terug voordat u energiebronnen voor dit apparaat inschakelt.</p>
<p> AVVIŻ</p> <p>L-installazzjoni u l-manutenzjoni għandhom jitwettqu minn persunal ikkwalifikat.</p>	<p> OPMERKING</p> <p>Installatie en onderhoud moeten worden verricht door gekwalificeerd personeel.</p>
<p>EL  ΚΙΝΔΥΝΟΣ</p> <p>Επικίνδυνη τάση. Κίνδυνος για τη ζωή ή σοβαρού τραυματισμού. Απενεργοποιήστε και ασφαλίστε όλη την ενέργεια που τροφοδοτεί τη συσκευή, προτού εργαστείτε σε αυτή. Τοποθετήστε ξανά όλα τα καλύμματα, προτού ενεργοποιήσετε την τροφοδοσία της συσκευής με ενέργεια.</p>	<p>GA  CONTÚIRT</p> <p>Voltaas contúirteach. Baol go bhfaighfear bás nó tromghortú. Mích arbeite cumhacht a sholáthraíonn an gléas seo agus glasáil amach í roimh obair a dhéanamh ar an ngléas seo. Cuir na clúdaigh ar fad ar ais roimh an gcumhacht a sholáthraíonn an gléas seo a chur ar siúl arís.</p>
<p> ΠΡΟΣΟΧΉ</p> <p>Η εγκατάσταση και συντήρηση πρέπει να διεξάγονται από εξειδικευμένο προσωπικό.</p>	<p> FÓGRA</p> <p>Ní mór don fheistiú agus don chothabháil a bheith déanta ag pearsanra cáilithe.</p>
<p>RO  PERICOL</p> <p>Tensiune periculoasă. Pericol de moarte sau de accidentări grave. Opriți și blocați alimentarea cu energie a acestui dispozitiv înainte de a lucra la acesta. Așezați la loc toate capacele înainte de a porni alimentarea cu energie a acestui dispozitiv.</p>	<p>SV  FARA</p> <p>Farlig spänning. Livsfara eller risk för allvarliga personskador. Innan arbete utförst på utrustningen ska strömförsörjningen till utrustningen stängas av. Montera alla skyddsplåtar igen innan utrustningen slås på.</p>
<p> ÎNȘTIINȚARE</p> <p>Instalarea și întreținerea trebuie să se efectueze de către personalul calificat.</p>	<p> OBS</p> <p>Installation och underhåll får endast utföras av kvalificerad personal.</p>
<p>CZ  NEBEZPEČÍ</p> <p>Nebezpečné napětí. Nebezpečí smrtelného nebo těžkého úrazu. Před zahájením prací na tomto zařízení odpojte a zajistěte veškeré přírůdy energie. Před opětovným připojením zařízení vraťte všechny kryty na svá místa.</p>	<p>SL  NEVARNOST</p> <p>Nevarna napetost. Nevarnost za življenje ali nevarnost hudih poškodb. Izklopite in prekinite celotno napajanje naprave, preden na njej opravljate dela. Preden napajanje znova vklopite, namestite vse pokrove.</p>
<p> POZNÁMKA</p> <p>Instalaci a údržbu musí provádět kvalifikovaní pracovníci.</p>	<p> OPOMBA</p> <p>Namestitev in vzdrževanje mora opraviti usposobljeno osebje.</p>
<p>SK  NEBEZPEČENSTVO</p> <p>Nebezpečné napätie. Nebezpečenstvo ohrozenia života alebo vzniku ťažkých zranení. Pred prácou na zariadení vypnite a zaistite všetky napájacie prípojky tohto zariadenia. Pred zapnutím napájania tohto zariadenia najprv nasad'te späť všetky kryty.</p>	<p>HU  VESZÉLY</p> <p>Veszélyes feszültség. Életveszély vagy súlyos sérülésveszély. Mielőtt bármilyen munkavégzést kezd az eszközön, az áramellátást le kell kapcsolni, és véletlen bekapcsolás elleni védelemmel kell ellátni. Az áramellátás visszakapcsolása előtt minden burkolatot vissza kell helyezni.</p>
<p> UPOZORNENIE</p> <p>Inštaláciu a údržbu musí vykonávať kvalifikovaný personál.</p>	<p> MEGJEGYZÉS</p> <p>A telepítést és a karbantartást kizárólag szakképzett személyzet végezheti.</p>

	EN  DANGER Hazardous voltage. Will cause death or serious injury. Turn off and lock out all power supplying this device before working on this device. Replace all covers before power supplying this device is turned on.
ES  PELIGRO Tensión peligrosa. Puede causar la muerte o lesiones graves. Antes de trabajar en este dispositivo, desconecte y bloquee todas las fuentes que lo alimentan eléctricamente. Recoloque todas las cubiertas antes de volver a conectar la alimentación eléctrica para este dispositivo.	FR  DANGER Tension électrique dangereuse. Danger de mort ou risque de blessures graves. Avant d'intervenir sur l'appareil, couper toutes les sources de tension et les consigner contre la refermeture. Remettre en place tous les couvercles avant de remettre l'appareil sous tension.

 **Required tools / Notwendige Werkzeuge / Outils nécessaires / Herramientas requeridas / 必要工具** 

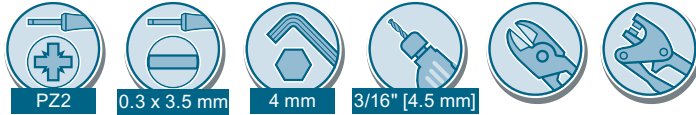

cal. ISO 6789

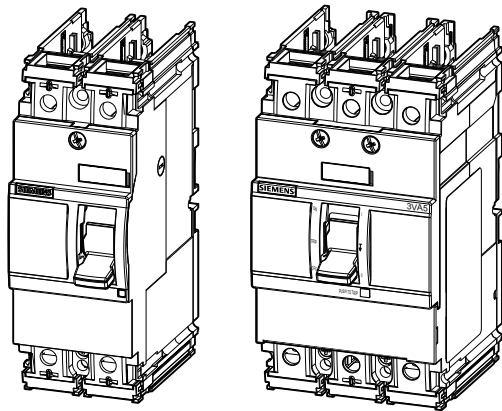

 **Contents / Etendue de la livraison / Alcance de suministro** 

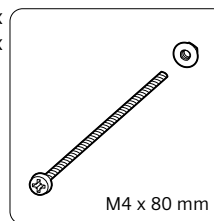

3VA5 125

2 P: 2 x
3 P: 2 x



 **Test / Test / Test / Test / 测试** 

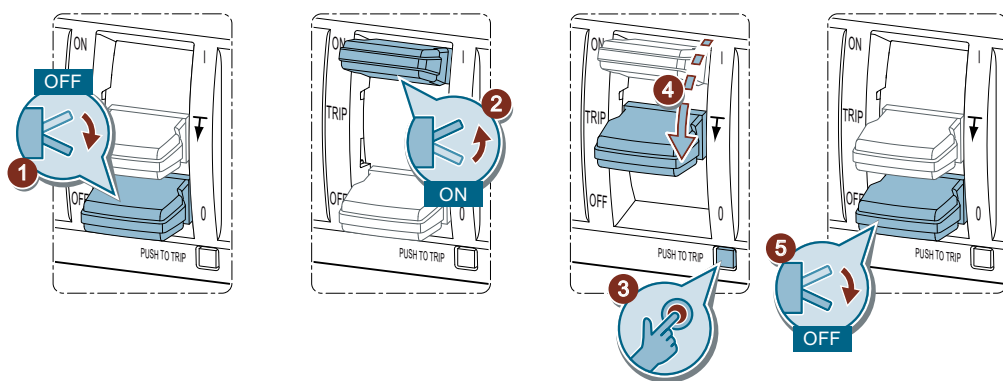



Information / Information / Informations / Información / 信息

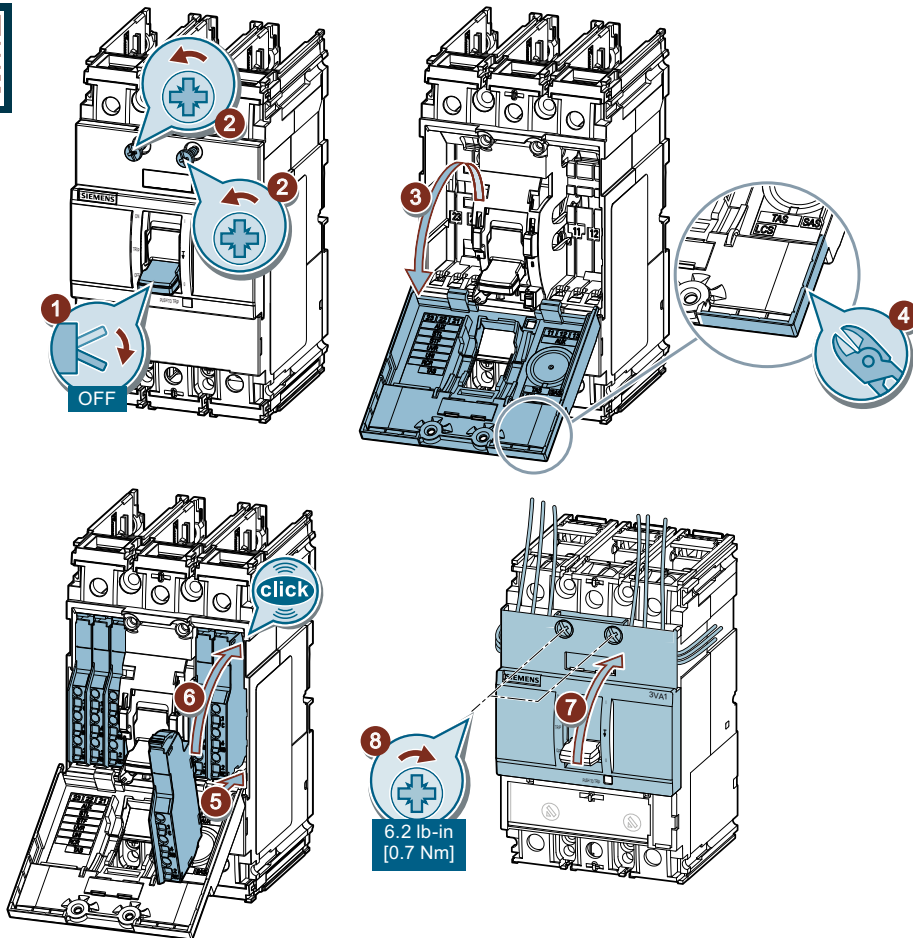

Assembly / Montage / Montage / Montaje / 安装



EN	Option
DE	Option
FR	Option
ES	Opción
IT	Opzione
PT	Opção
TR	Opsiyon
RU	Опция
PL	Opcja
中	选项

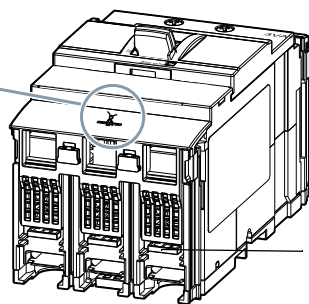
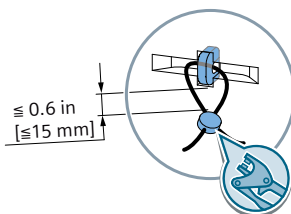

3VA9151 - 0WD.0





Information / Information / Informations / Información / 信息















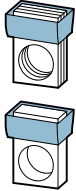

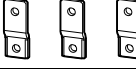

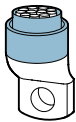
DE **⚠️ GEFAHR**
Lichtbogengefahr. Lebensgefahr oder schwere Verletzungsgefahr.
 Eine der aufgeführten Isolationsmaßnahmen muss, entsprechend den spezifischen Anwendungsparametern, vorgenommen werden.

EN **⚠️ DANGER**
Arcing hazard. Will cause death or serious injury.
 One barrier method must be applied, as noted, per the specific application parameters.

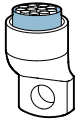
FR **⚠️ DANGER**
Danger d'arc. Danger des mort ou risque de blessures graves.
 Une méthode de barrière faut utilisées, comme indiqué, conformément à paramètres spécifiques de la utilisation

	EN  DANGER Hazardous voltage. Will cause death or serious injury. Turn off and lock out all power supplying this device before working on this device. Replace all covers before power supplying this device is turned on.
ES  PELIGRO Tensión peligrosa. Puede causar la muerte o lesiones graves. Antes de trabajar en este dispositivo, desconecte y bloquee todas las fuentes que lo alimentan eléctricamente. Recoloque todas las cubiertas antes de volver a conectar la alimentación eléctrica para este dispositivo.	FR  DANGER Tension électrique dangereuse. Danger de mort ou risque de blessures graves. Avant d'intervenir sur l'appareil, couper toutes les sources de tension et les consigner contre la refermeture. Remettre en place tous les couvercles avant de remettre l'appareil sous tension.
ES  PELIGRO Peligro de arco eléctrico. Puede causar la muerte o lesiones graves. Es necesario aplicar, en base a los parámetros específicos de la aplicación, uno de los métodos de aislamiento indicados.	IT  PERICOLO Pericolo di formazione d'arco elettrico. Può provocare la morte o gravi lesioni. Deve essere applicato un metodo di barriera, come già menzionato, che sia conforme ai parametri dell'applicazione.
PT  PERIGO Perigo de formação de arco voltaico. Perigo de morte ou ferimentos graves. É necessário aplicar um método de barreira de separação, como referido, de acordo com os parâmetros de aplicação específicos.	TR  TEHLİKE Kıvılcım tehlikesi. Ölüm ya da ciddi yaralanmaya sebebiyet verir. Özel uygulama parametrelerinde belirtildiği şekilde tek bariyer yöntemin-den yararlanılmalıdır.
PY  ОПАСНО Опасность электрической дуги. Может привести к смерти или серьезным травмам. Метод барьера должен быть применен, как уже отмечено, в соответствии с прикладными параметрами.	PL  ZAGROŻENIE Ryzyko wyładowań łukowych. Mogą powodować utratę życia lub poważne obrażenia. Jak już wspomniano, należy zastosować jedną z metod ochronnych dla określonych parametrów użycia.
中  危險 电弧危险。将导致死亡或重伤。 必须如所述那样，根据特定应用参数应用一种屏障法。	HR  OPASNOST Opasnost od iskrenja. Opasnost po život ili opasnost od teških ozljeda. Potrebno je koristiti metodu jedne prepreke, kao što je navedeno, po posebnim parametrima primjene.
FI  VAARA Valokaaren vaara. Seurauksena on vakava loukkaantuminen tai kuolema. Yhden suojauskeinon käyttö on pakollista käyttökohteen erityisten parametrien mukaisesti, kuten on ilmoitettu.	БГ  ОПАСНОСТ Опасност от електрическа дъга. Може да причини смърт или сериозни наранявания. Трябва да се използва метод с една преграда в съответствие с указанията и параметрите за конкретното приложение.
EE  OHT Keevituskare oht. Võib olla eluohtlik või tekitada tõsiseid vigastusi. Rakendada tuleb ühte tõkkemeetodit vastavalt spetsiifilistele rakendusparameetritele.	LV  BĪSTAMI Lokizlādes risks. Izraisa nāvi vai smagus miesas bojājumus. Vienas barjeras metode saskaņā ar minēto jāizmanto katras konkrētās ierīces parametriem.
LT  PAVOJUS Lanko susidarymo pavojus. Sukels mirtį arba rimtą sužalojimą. Konkrečių naudojimo atvejų parametrams reikia taikyti, kaip nurodyta, vieno barjero metodą.	DA  FARE Lysbud fare. Forårsager død eller alvorlige kvæstelser. En afspærringsmetode skal bruges, som nævnt, efter de specifikke anvendelsesparametre.
MT  PERIKLU Periklu ta' arkjar (arcing). Dan jista' jikkawża mewt jew korrimenti gravi. Kif ġie nnotat, jista' jintuża metodu ta' protezzjoni wieħed biss skont il-parametri speċifiċi tal-applikazzjoni.	NL  GEVAAR Gevaar van vonken. Leidt tot de dood of ernstig letsel. Er moet een blokkeringsmethode zijn toegepast (zoals opgemerkt) via de specifieke toepassingsparameters.
EL  ΚΙΝΔΥΝΟΣ Κίνδυνος σπινθηρισμών. Προκαλείται θάνατος ή σοβαρός τραυματισμός. Πρέπει να εφαρμόζεται μία μέθοδος φραγμού, όπως επισημαίνεται, για τις συγκεκριμένες παραμέτρους εφαρμογής.	GA  CONTÚIRT Baol stuála. Beidh sé ina chúis bháis nó tromghortaithe Ní mór modh coiscthe amháin a fheidhmiú mar a cuireadh in iúl, de réir na bparaiméadar feidhme sainiúla.
RO  PERICOL Pericol de arc electric. Acesta va provoca decesul sau o vătămare gravă. Trebuie să se aplice o metodă de barieră, conform indicațiilor, ținând cont de parametrii specifici ai aplicației.	SV  FARA Överslagsrisk. Kommer att orsaka dödsfall eller allvarliga personskada. Som nämnts måste en barriärmetod tillämpas enligt de specifika applikationsparametrarna.
SK  NEBEZPEČENSTVO Nebezpečnost vzniku el. oblúka. Nebezpečnost ohrozenia života alebo vzniku vážnych zranení. Použitý musí byť jeden spôsob vytvorenia bariéry, ako to už bolo uvedené, podľa parametrov konkrétnej aplikácie.	SL  NEVARNOST Nevarnost iskrenja. Nevarnost za življenje ali nevarnost hudih poškodb. Uporabiti je treba eno metodo blokade, kot je navedeno, glede na parametre specifične aplikacije.
CZ  NEBEZPEČÍ Nebezpečí vzniku elektrického oblouku. Může způsobit usmrcení nebo vážné poranění Je nezbytné použít uvedenou metodu jedné bariéry dle specifických parametrů dané aplikace.	HU  VESZÉLY Ívkiülés veszélye. Halált vagy komoly sérülést okoz. Ahogy már említettük, az adott alkalmazási paramétereknek megfelelő szigetelési módot kell alkalmazni.

Connection / Anschluss / Raccordement/ Conexión / Connessione / Conexão / Bağlantı / соединение / Połączenie / 连接				
		TA1.0	3VA913.-0JB10 3VA913.-0JG10	—
		TC1.0	3VA913.-0JD10 3VA913.-0JK10	
		TA1.1	3VA913.-0JB11 3VA913.-0JG11	
		TC1.1	3VA913.-0JD11 3VA913.-0JK11	
		TS1.1	3VA913.-0JA11	
		TA2.1	3VA913.-0JJ12 3VA913.-0JC12	
TA2.5		3VA913.-0JF60		
		3VA913.-0QA00	—	
		3VA913.-0QB00	D F	
		3VA913.-0QE.0	—	
		3VA913.-0QA00	—	
		3VA913.-0QB00	D F	
		3VA913.-0QF.0	—	
		3VA913.-0QA00	D F	
		3VA913.-0QB00	D F	
		3VA913.-0QF.0	—	

match barrier requirements / Isolationsanforderungen einhalten / Exigences de barrières respectées / Cumplir requisitos de aislamiento entre fases / coordinare i requisiti per barriera di separazione / corresponde aos requisitos da barreira / bariyer gereksinimlerini eşleştir / соответствуют требованиям к барьеру / dorasuj wymagania dot. barier / 匹配屏障要求

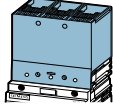
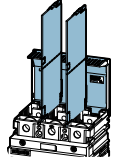
D		3VA9131-0WF.0
F		3VA9132-0WA00 3VA9131-0WJ.0

— no barrier requirements / keine Isolationsanforderungen / Pas d'exigences de barrières / No hay requisitos de aislamiento entre fases / nessun requisito per barriera di separazione / não há requisitos de barreira / bariyer gereksinimleri yok / требования к барьеру отсутствуют / brak wymagań dot. barier / 无屏障要求



EN

⚠ DANGER

Hazardous voltage. Will cause death or serious injury. Turn off and lock out all power supplying this device before working on this device. Replace all covers before power supplying this device is turned on.

ES

⚠ PELIGRO

Tensión peligrosa. Puede causar la muerte o lesiones graves. Antes de trabajar en este dispositivo, desconecte y bloquee todas las fuentes que lo alimentan eléctricamente. Recoloque todas las cubiertas antes de volver a conectar la alimentación eléctrica para este dispositivo.

FR

⚠ DANGER

Tension électrique dangereuse. Danger de mort ou risque de blessures graves. Avant d'intervenir sur l'appareil, couper toutes les sources de tension et les consigner contre la refermeture. Remettre en place tous les couvercles avant de remettre l'appareil sous tension.



Information / Information / Informazioni / Información / 信息

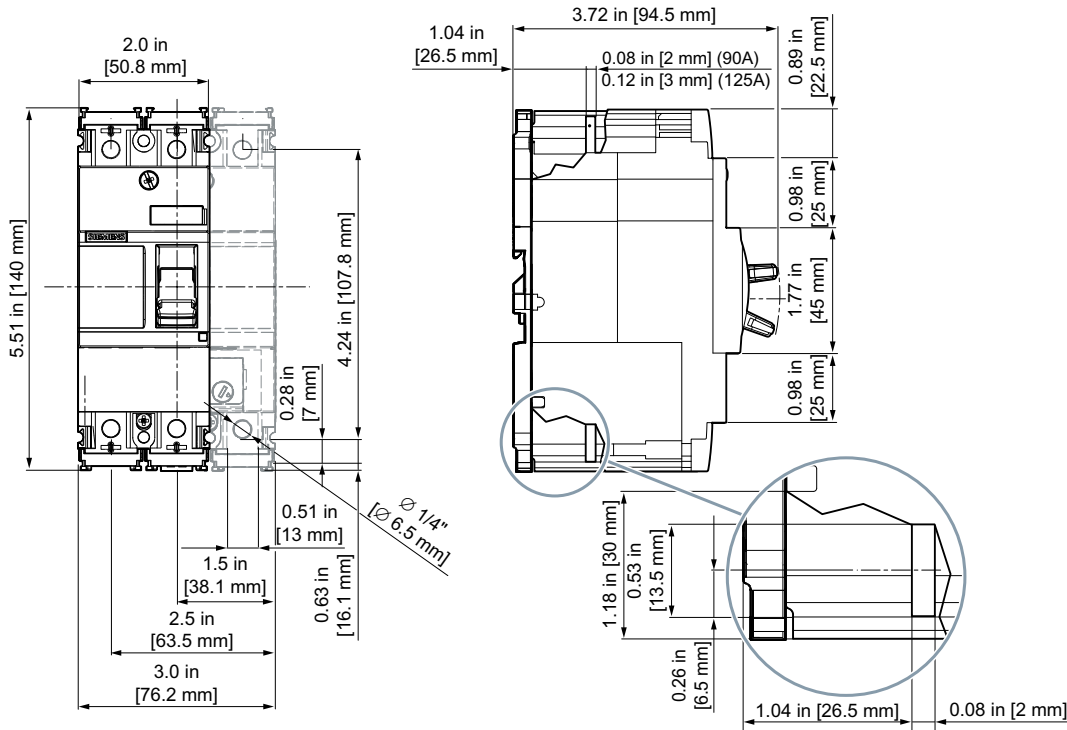

Assembly / Montage / Montage / Montaje / 安装

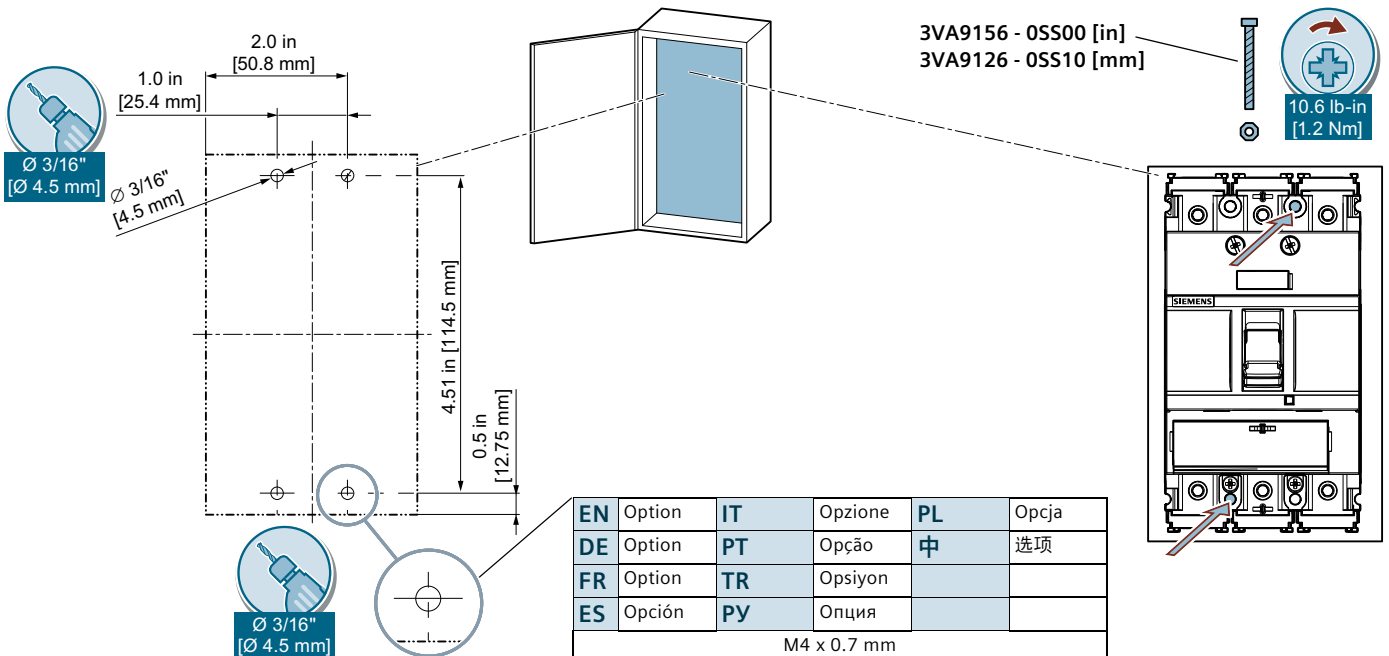

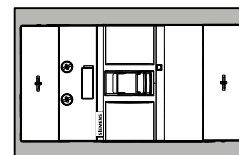
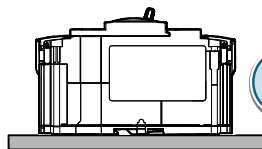
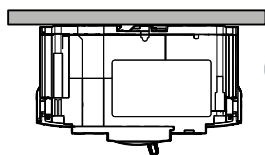
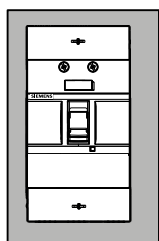
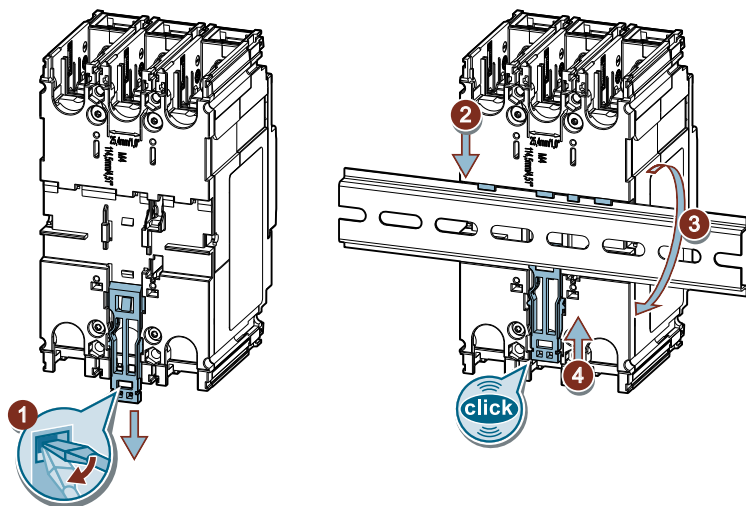

EN

NOTICE

These instructions do not purport to cover all details or variations in equipment, or to provide for every possible contingency in connection with installation, operation, or maintenance. Should additional information be desired, please contact the local Siemens sales office. The contents of this instruction manual shall not become part of or modify any prior or existing agreement, commitment, or relationship. The sales contract contains the entire obligation of Siemens. The warranty contained in the contract between the parties is the sole warranty of Siemens. Any statements contained herein do not create new warranties or modify the existing warranty.

Trademarks - Unless otherwise noted, all names identified by ® are registered trademarks of Siemens AG or Siemens Industry, Inc. The remaining trademarks in this publication may be trademarks whose use by third parties for their own purposes could violate the rights of the owner.