

Catalog Number: UA4311-0PZA

Features and Ratings

- Ringless Type Meter Socket
- 100A Continuous, 4 Position, 200A Overall
- Outdoor Enclosure (NEMA Type 3R)
- Painted G90 Steel
- 1 Phase, 3 Wire, 600V AC
- 4 Jaw, Horn Bypass
- 7/16" Barrel Lock Provision w/Bracket
- For Overhead or Underground Service
- RX Type (small) Hub Opening

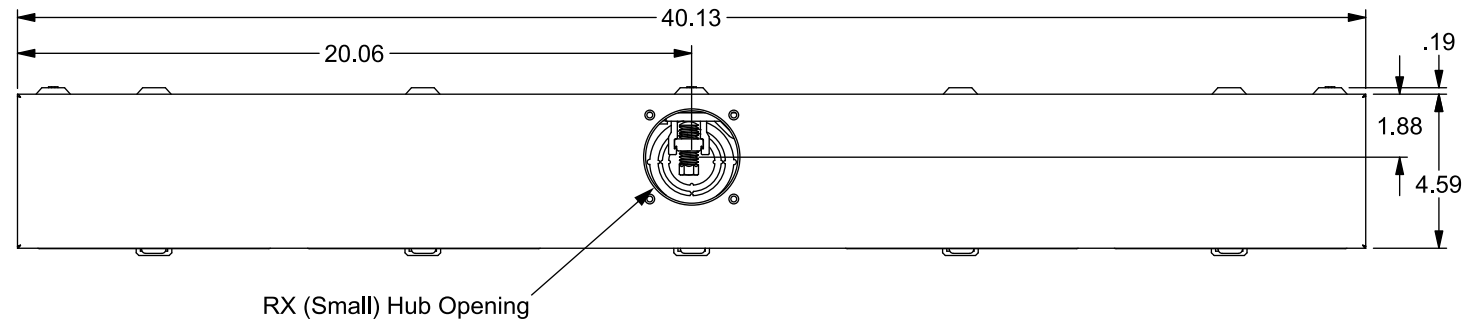

View Shown with Covers Removed

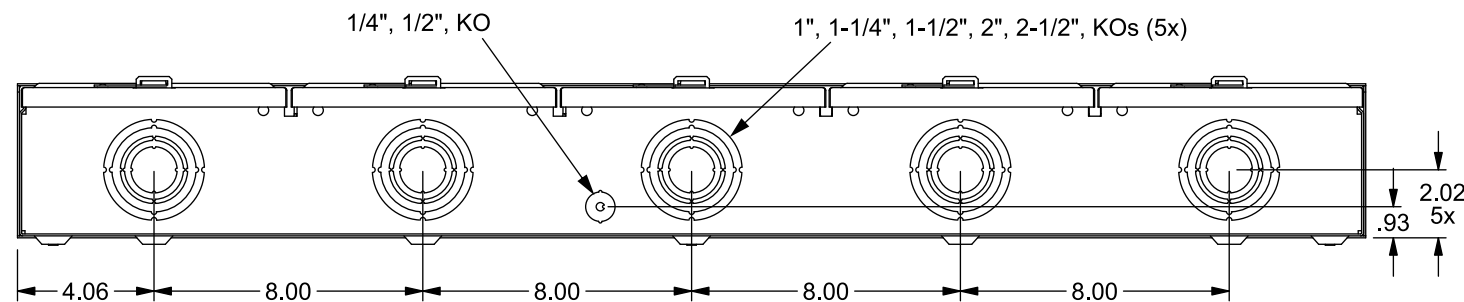
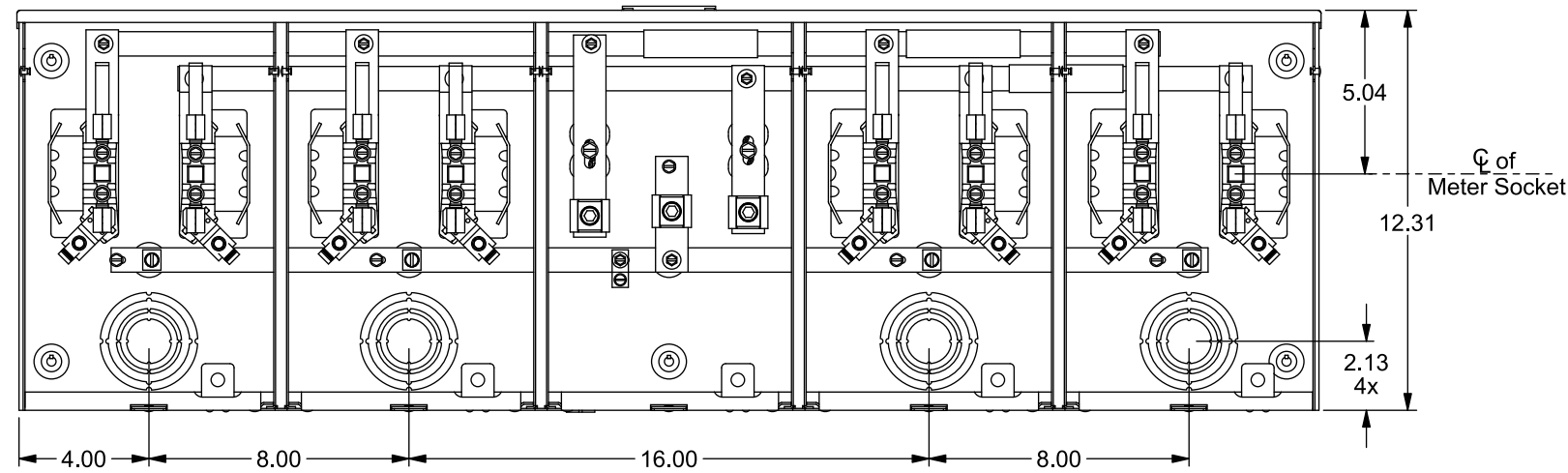

Accessories

Meter Opening Cover Plate
Cat No: H659-0162

5th Jaw Kit
Cat. No: 659-0121

CONDUIT HUBS (RX Type)	
TRADE SIZE	CATALOG No.
1-1/4 INCH	EC38597 or H38597-2
1-1/2 INCH	EC38598 or H38598-2
2 INCH	EC38599 or H38599-2
2-1/2 INCH	EC38600 or H38600-2
Hub Cover Plate	EC38595 or H38595-1

Connectors, Wire Sizes and Torques

CONNECTOR	WIRE SIZE	TORQUE
LINE, NEUTRAL*	#6 - 350 kcmil	250 IN.-LBS.
LOAD, NEUTRAL	2/0 - #14	50 IN.-LBS.
GROUND	#14 - 2 (CU)	50 IN.-LBS.

* External Hex Drive 1/2"
* Internal Hex Drive 5/16"

WIRE BENDING SPACE PROVIDED FOR 350 kcmil WIRE

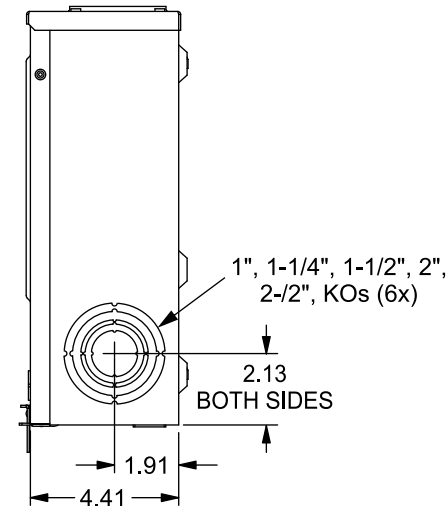
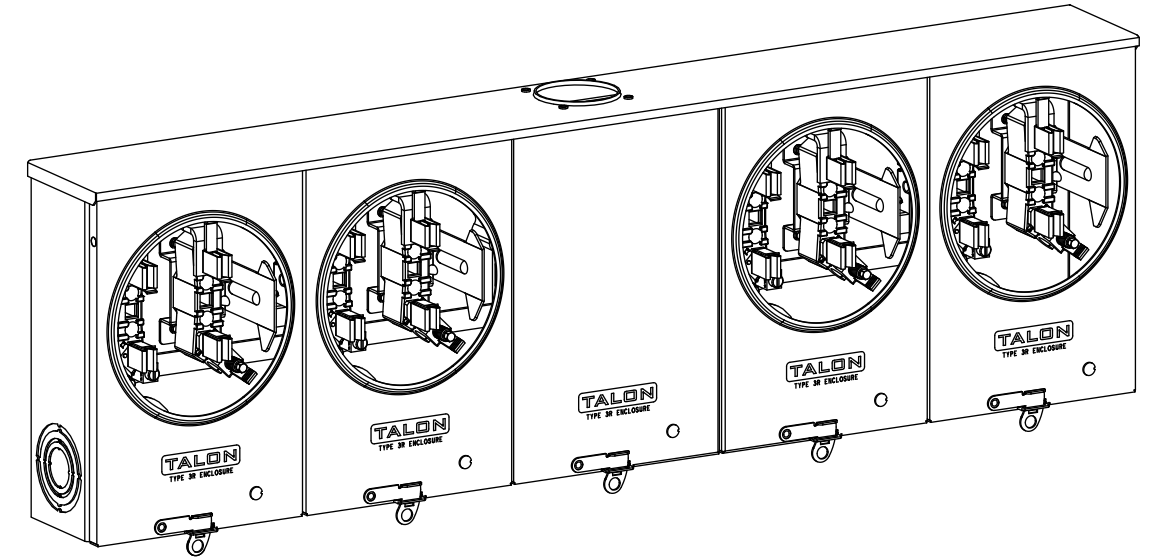

© 2018 Copyright Siemens Industry, Inc.

TALON

Multi-Position Metering

Description:
100A Cont, 4 Jaw, A12-4POS, 7/16" B/L, Horn Bypass, 600VAC, Painted G90 Steel

KAM 7/2/18 DO NOT SCALE DRAWING Dwg No: UA4311-0PZA